

Modular System

System Overview

Modular System

Consumer Unit – MC200 Series

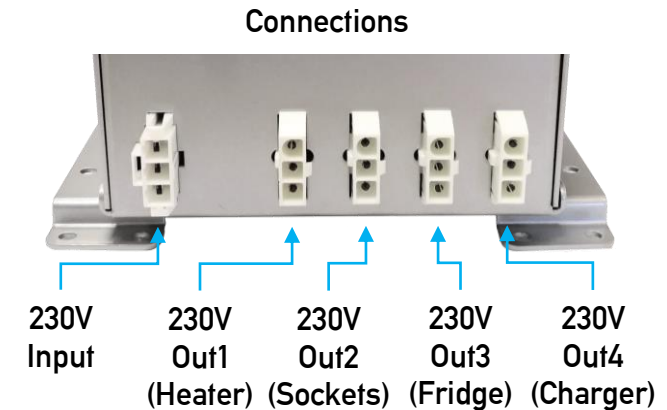
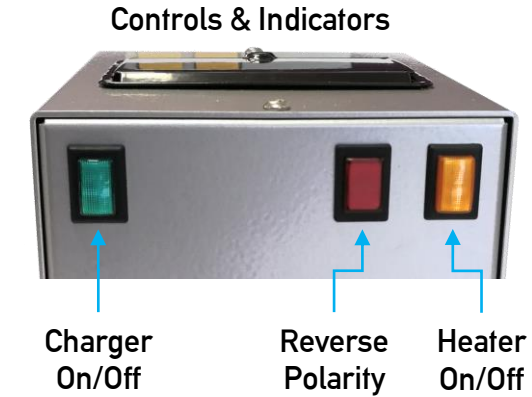
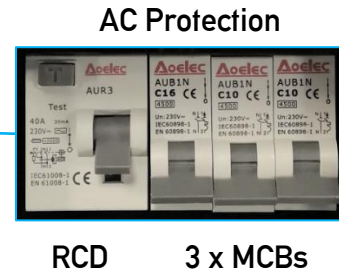
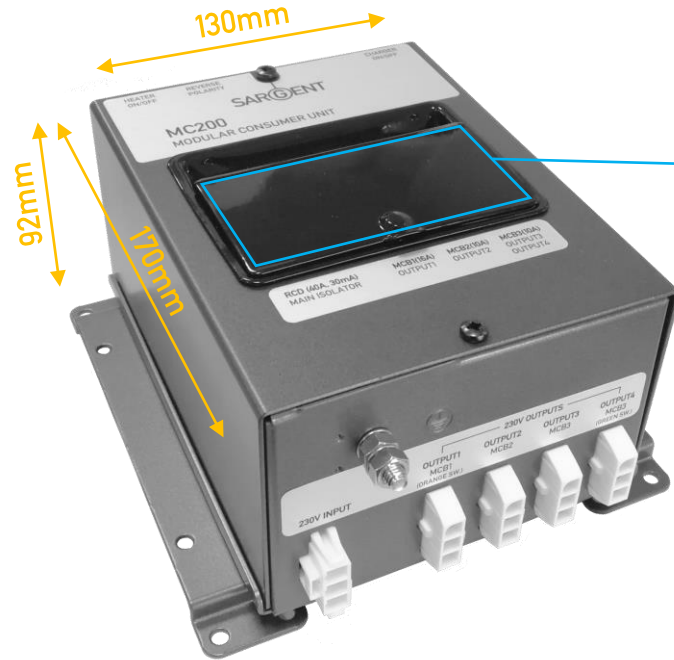

- Built-in RCD & MCB protection
- Integrated switching for heater & charger
- Reverse polarity indicator
- Plug & Play for rapid fitment

Modular System

Control Unit – MC100 Series

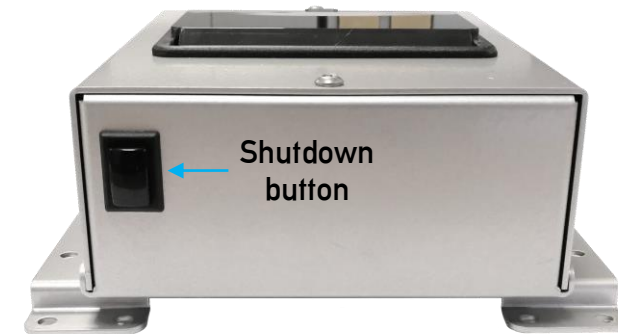
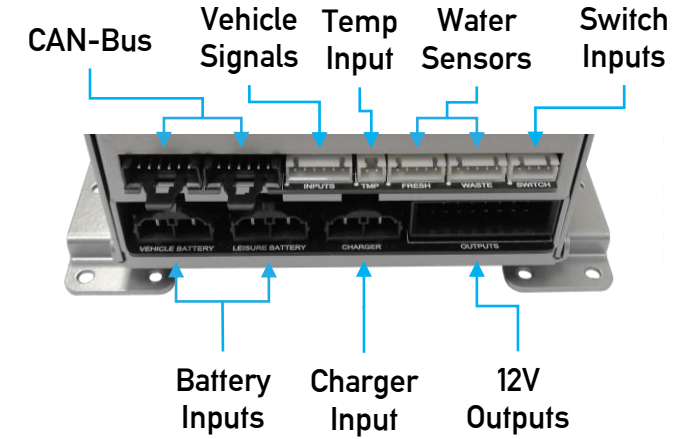
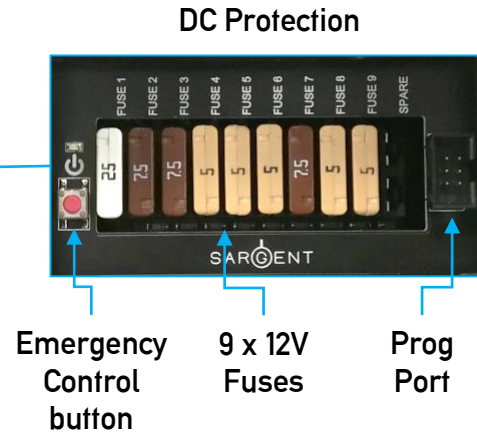
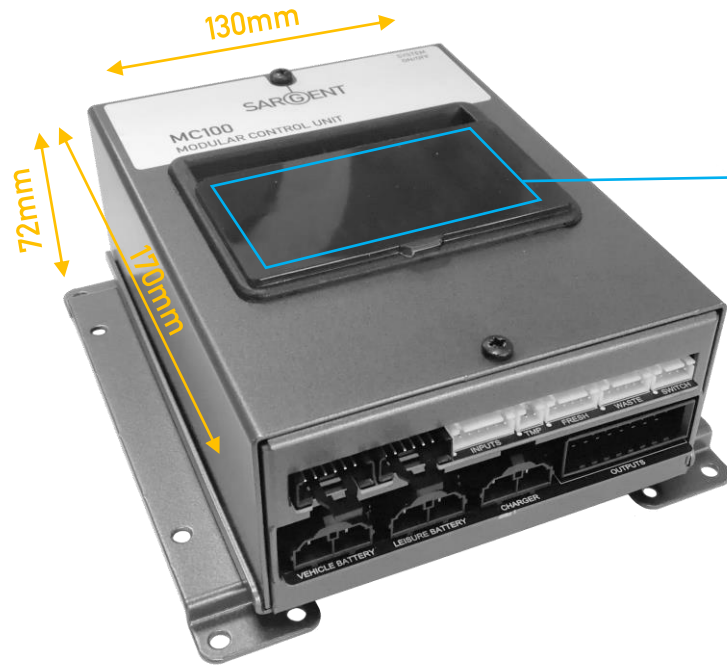

- Compact footprint - ideal for campers
- 8 x 12 volt output channels
- Dimmable lighting output
- Fresh & Waste tank inputs
- Internal & External temperature inputs

Modular System

Fitting

The system can be fitted as a single unit or split into separate units where space is at a premium

Single Unit



Central bracket connects AC & DC units together

Dual Units

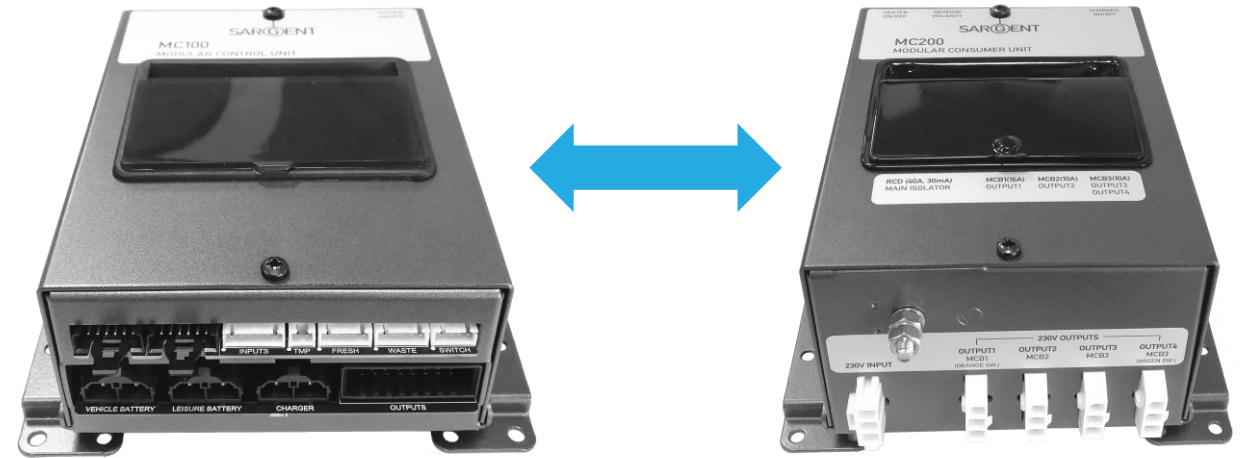

Modular System

Control Panel – EC940



- 4" touchscreen LCD display
- Intuitive graphical interface
- Context sensitive help screens
- Quick install design



Lighting controls with dimming channel

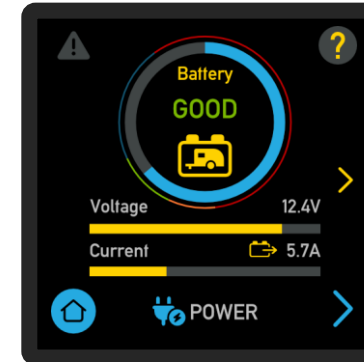

Battery selection and power monitoring

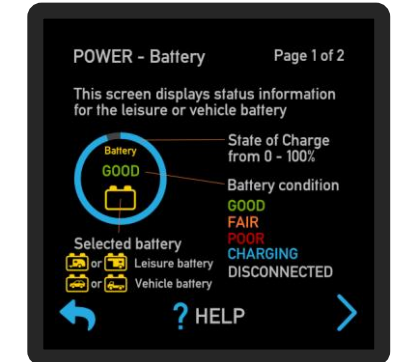

Context sensitive help for most screens

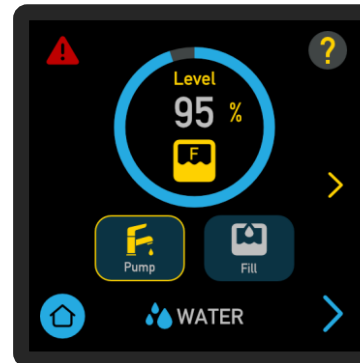

Water tank monitoring and pump controls

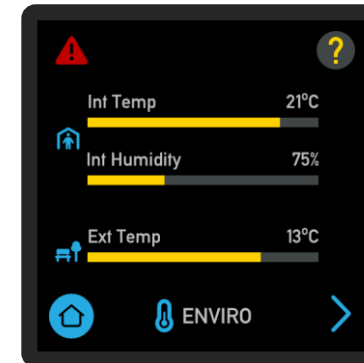

Environmental sensors display



Panel fixes in place without using screws

Modular System

Control Panel – EC970



- 7" touchscreen LCD display
- Intuitive graphical interface
- Context sensitive help screens
- Quick install design

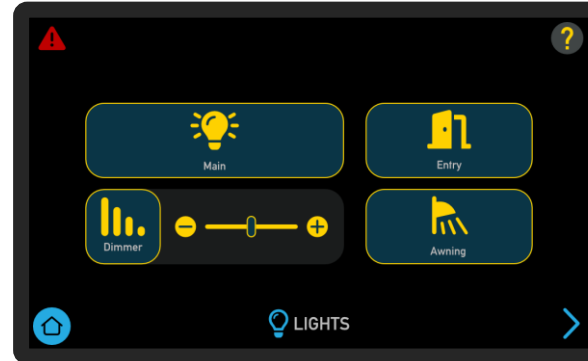

Lighting controls with dimming channel

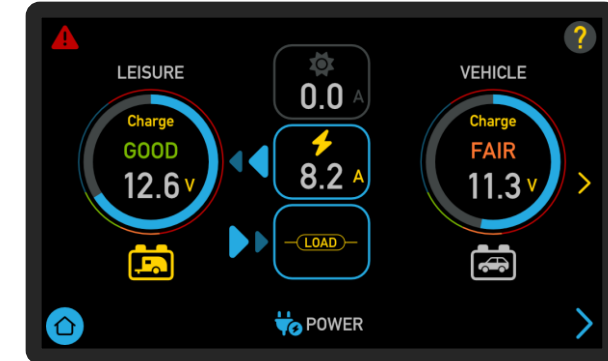

Battery selection and power monitoring

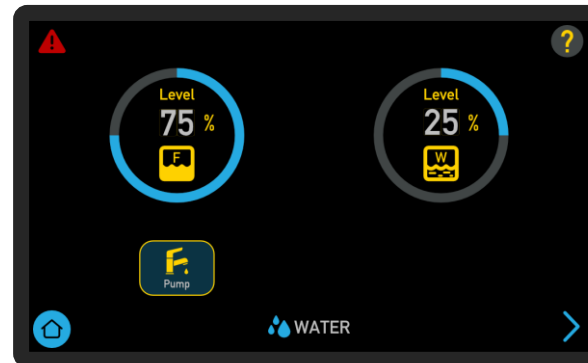

Water tank monitoring and pump controls

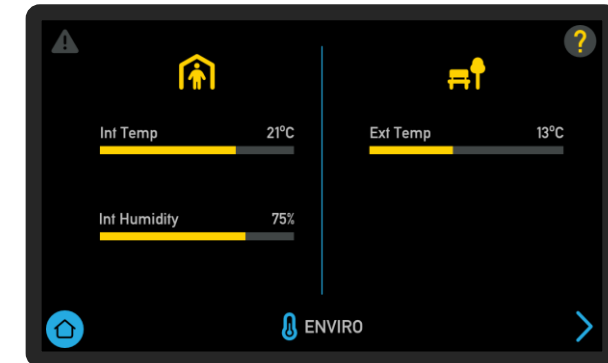

Environmental sensors display

Modular System

Architecture

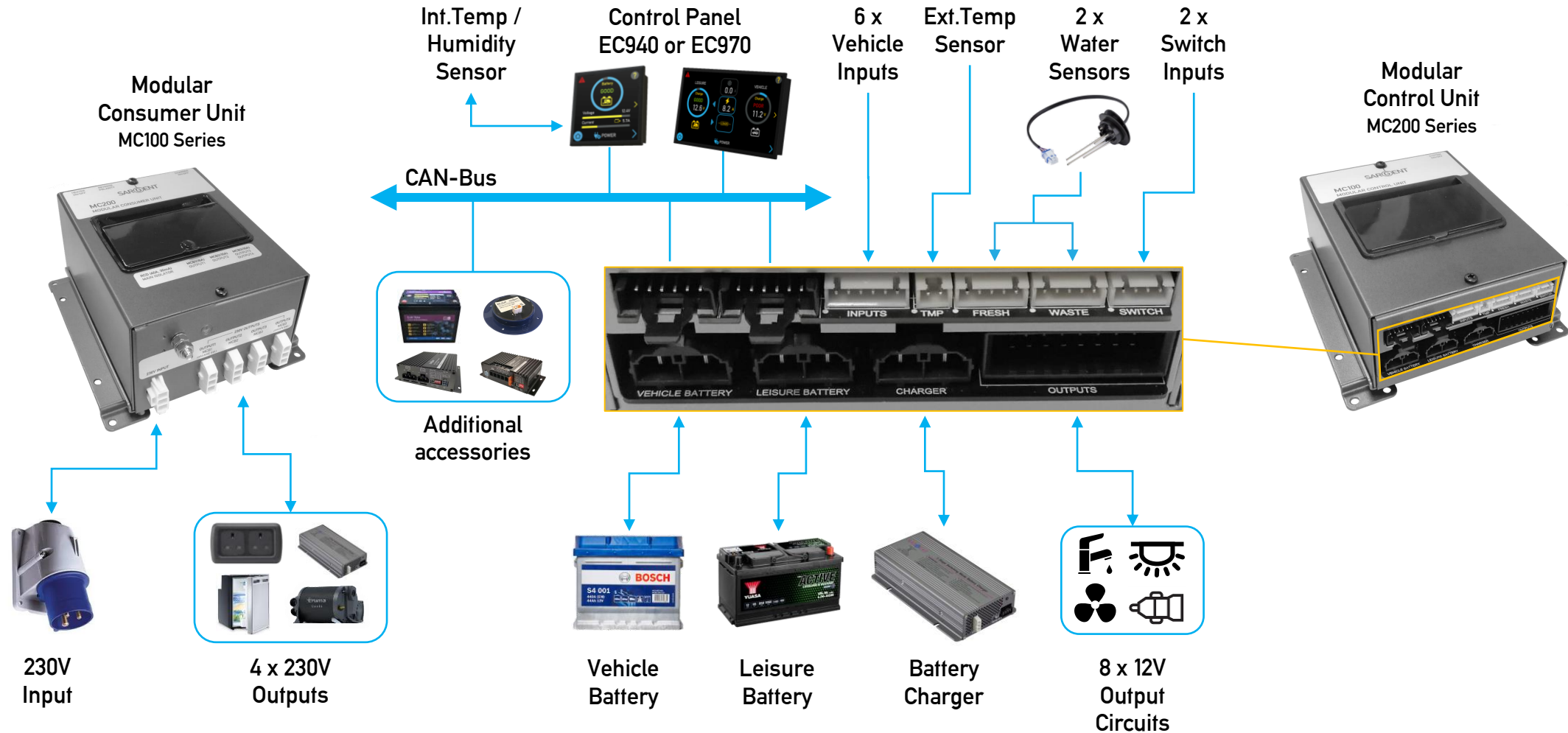

Modular System

CANBus Accessories - Overview

Additional CANBus accessories can be added and enabled within the control panel

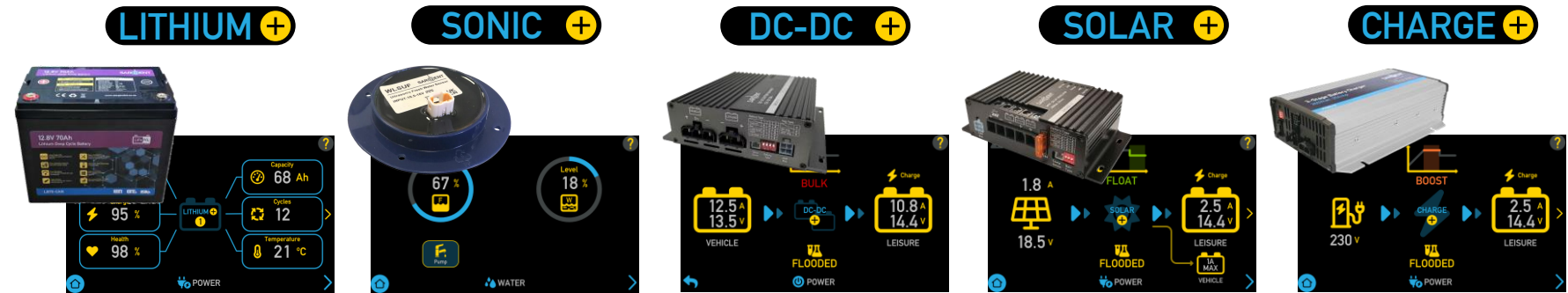

Control Panel	Lithium Battery	Ultrasonic water sensor	30A DC-DC charger	300W solar regulator	25A AC-DC charger
EC940 with 4" display	■	■		■	
EC970 with 7" display	■	■	■	■	■

Available NOW

Available NOW

Available March 24

Available March 24

Available Q3/24

Modular System

CANBus Accessories – Lithium Batteries



- Long Cycle Life
- Light Weight
- More Useable Capacity
- Fast Charging

LITHIUM+

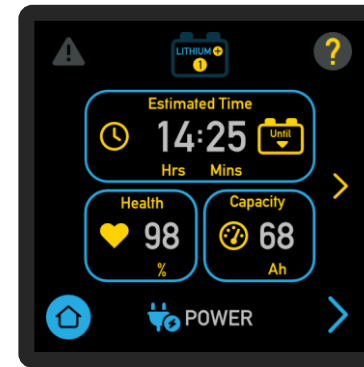

EC940 Lithium+ Display

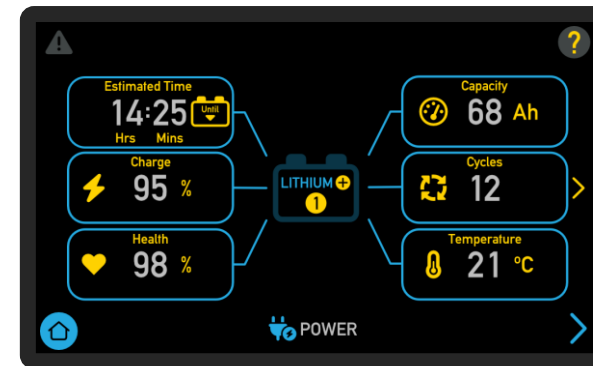

EC970 Lithium+ Display

When using Lithium+ additional useful data is available on the display such as time remaining, charge, health and capacity

Modular System

CANBus Accessories – Ultrasonic Water Sensors



When using Sonic+ the water level readings are more accurate than normal sensors and can be displayed in 1% steps

- Accurate measurement
- Ultrasonic sensing technology
- Automatic calibration
- Models for fresh & waste tanks
- Fully sealed

SONIC +

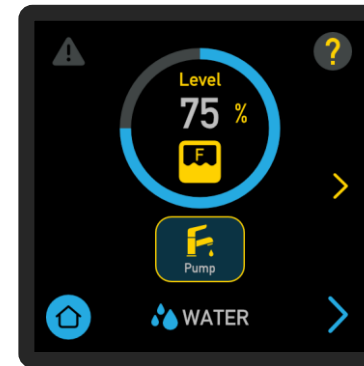

EC940 Sonic+ Display

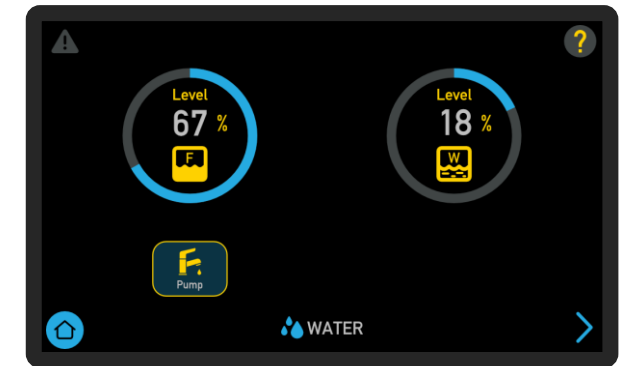

EC970 Sonic+ Display

